

the fine art of heating



Cannon[®]
Gas Log Heaters

Every **Cannon** heater is a masterpiece

Only a true craftsman continually refines and remasters their design until the outcome appears effortless. That expertise is why the functionality of each Cannon Gas Log Heater seamlessly lends itself to stylish form.

A selection of settings controlling the heat and fan of your heater, electronic switching, optional remote controlled thermostat and stainless steel internal panels that enhance the flame effect are simply a few of the features of this stunning collection.



Canterbury Freestanding (CANTFS-SDEEB) with optional mesh guard.



Our design specialists have taken the functional necessities of useability, energy efficiency and safety, then created a form that unobtrusively enhances any room. They've expertly sculpted logs with the skill of an artist and maximised the flame-view area to infuse our range of gas log heaters with unquestionable authenticity.



Fitzroy Inbuilt Platinum (FITZIB-SMEXP) with standard mesh guard.

Installation options

Versatility and flexibility are key components of our installation options. Install in a shallow recess or an existing fireplace, elegant spacers will eliminate any size discrepancies. To enhance your Cannon's appearance add a decorative 3 or 4 sided surround.

Every Cannon heater brings you the optional convenience of controlling your heater through a remote thermostat.

For added convenience the heater can now be connected to a home automation system, such as C-bus. This allows the heater to be turned on or off remotely (low heat setting only).



Fitzroy glass kit



Remote thermostat



Spacer kit



Canterbury mesh guard



Console kit



Surround kit



Fitzroy freestanding kit



Weatherproof box



Mock fireplace kit

Fitzroy glass kit

The Fitzroy models are supplied with a mesh fascia which can be easily upgraded to a double glazed glass fascia, as both are fully interchangeable. The Fitzroy glass fascia extends across the front of the heater to give sophisticated clean lines and a superb finish.

Remote thermostat

The remote has an LCD display and the ability to set hour, minute and day functions, plus up to 28 programmable periods. It also has manual and automatic modes and can't be accidentally turned on.

Spacer kit

When installing into a shallow fireplace cavity, the 50 mm spacer kit helps to provide the minimum clearance at the rear by bringing the heater forward.

Canterbury mesh guard kit

Our mesh guard is strong, tough and safe. Engineered for the ultimate in protection, there is a mesh guard available for both the inbuilt and freestanding Canterbury models.

Console kit

A decorative cover that fits around the heater to allow installation against an existing wall without building a mock fireplace or installing a mantelpiece.

Surround kit

Decorative surround kits allow the heater to be installed into existing fireplaces where the fireplace opening is larger than the heater. Available in black, platinum or stainless steel, 3 sided (75 mm) or 4 sided (97 mm) surround.

Fitzroy freestanding kit

The Fitzroy freestanding kit converts either the FITZIB-SMENB or the FITZIB-SMEXB inbuilt heaters into freestanding units. The kit comes complete with the pedestal, outer casing and flue kit.

Weatherproof box

The weatherproof box is designed to protect the back of the Powerflue Fitzroy heater from the elements when installed on an external wall without a mock fireplace.

Mock fireplace kit

The mock fireplace kit ensures the inbuilt Cannon heaters can be installed safely into combustible areas such as timber or plasterboard mock fireplaces.

The **Fitzroy** range

All you have to do is, switch it on...

All models in our inbuilt Fitzroy range unite incomparable features with minimum fuss. The easy to use electronic switching comes standard with each model. For greater convenience, add an optional remote controlled thermostat.

All models have a choice of three or four sided surrounds in black, stainless steel or platinum finish. If, however you prefer a freestanding model then choose from the two Fitzroy inbuilts that can be optioned as a freestanding heater (see page 8-9).

The Powerflue is a true masterpiece. While maintaining convenience and aesthetics it can vent up, down and horizontally out the back, making it the perfect solution for heating every floor in a multi-storey dwelling. Added to this versatility, the Powerflue is a highly efficient heater, and depending on flue choice, is rated up to 5.50 stars.





Fitzroy Inbuilt Platinum (FITZIB-SMEXP) with standard mesh guard.



Fitzroy (FITZIB-SMEXB) with optional freestanding and glass kits.

Fitzroy Freestanding Kit



FITZIB-SMENB



FITZIB-SMEXB

Clean lines and concealed controls ensure a stylish, minimalist design teamed with high efficiency and heat output.

Installation is simple as only minimal clearances to combustible surfaces are required.

Can be safely placed on all floor surfaces making it suitable for the family rooms and large living areas of modern Australian homes.

Create your own free-standing masterpiece.

It couldn't be any simpler to convert an inbuilt Fitzroy into an impressive freestanding unit.

First choose from either the FITZIB-SMENB or the FITZIB-SMEXB, and simply add the Fitzroy freestanding kit (FITZFSKITX-B) and you are done.

You can choose to add the remote thermostat and/or Fitzroy glass kit to complete your masterpiece.

The Fitzroy freestanding kit comes complete with the heater casing, pedestal stand and flue kit.



FITZFSKITX-B

Options



Remote thermostat



Fitzroy glass kit



Fitzroy Inbuilt (FITZIB-SMEXB) with optional 4 sided, stainless steel surround and standard mesh guard kits.

Fitzroy Inbuilt ★ ★ ★ ★



FITZIB-SMENB



FITZIB-SMEXB



FITZIB-SMEXP

Designed for Australian needs,

the Fitzroy inbuilt has become a proven favourite.

Clean, fuss free design with high efficiency and heat output.

Neatly fits the cavity of existing gas/oil space heaters. A flue is not required when installed in a tested and fully functional fireplace, reducing the installation costs.

A mock fireplace kit makes your heater suitable for installation against timber or plasterboard (combustible surfaces).

See mock fireplace kit page 20 for specifications.

Standard Features

- + Electronic side controls
- + Electronic ignition
- + 3 heat settings
- + 3 speed fan
- + Realistic eucalypt look logs
- + Standard mesh safety guard
- + Enhanced flame effect (except FITZIB-SMENB)
- + Metallic Black baked enamel finish (FITZIB-SMENB & FITZIB-SMEXB)
- + Platinum Finish (FITZIB-SMEXP)
- + Heats 80 m² on average
- + 4.06 star energy rating

Options



Fitzroy freestanding kit



Fitzroy glass kit



Remote thermostat



Spacer kit



Mock fireplace kit



Surround kit



Console kit



Fitzroy Inbuilt Powerflue (FITZIB-PMEXB) with optional glass kit.

Fitzroy Powerflue ★ ★ ★ ★ ★



FITZIB-PMEXB

5 star energy rated, the Powerflue is the ideal choice for the energy conscious. The double flue system draws air from the outside for combustion and vents the flue gases outside.

Flexible flue options take Cannon built in heaters into new territory. See page 21 for more details.

Clever design flaunts convention, letting you install it on any external wall, even in a multi-storey dwelling.



Standard Features

- + Electronic side controls
- + Electronic ignition
- + 3 heat settings
- + 3 speed fan
- + Realistic eucalypt look logs
- + Standard mesh safety guard
- + Enhanced flame effect
- + Metallic black baked enamel finish
- + Flexible flueing options
- + Supplied with 2 lengths of 400 mm of ducting and a mock installation kit
- + Heats 80 m² on average
- + Suitable for use in 5 star energy rated homes
- + Star energy rating: 5.05 with flue 400 mm long, 5.50 for flues 6.0 m long

Options



Fitzroy glass kit



Remote thermostat



Spacer kit (shown on Canterbury)



Weatherproof box



Surround kit



Console kit

The **Canterbury** range

Make every home coming warm and inviting.

Smooth, curved lines exemplify the workmanship of the Canterbury range. Designed to fit into any existing wall cavity, both models offer a trio of fan speeds, heat settings and electronic switches. Choose from freestanding or inbuilt and still enjoy double glazed glass, an enhanced flame effect and the option of a remote thermostat.





Canterbury Freestanding (CANTFS-SDEEB) with optional mesh guard.



Canterbury Inbuilt (CANTIB-SDEEB).

Canterbury Inbuilt ★ ★ ★ ★



CANTIB-SDEEB

Gently curving front glass

that continues through the surround makes a refined, elegant statement.

Safe double glazed glass gives you an unobstructed view of your fire.

Replace old gas /oil space heaters

with minimum effort. A flue is not required when installed in a tested and fully functional fireplace, reducing the installation costs.

A mock fireplace kit is also available for installation against timber or plasterboard. See mock fireplace kit page 20 for specifications.

Standard Features

- + Electronic side controls
- + Electronic ignition
- + 3 heat settings
- + 3 speed fan
- + Realistic eucalypt look logs
- + Standard double glazed glass
- + Enhanced flame effect
- + Metallic black baked enamel finish
- + Heats 80 m² on average
- + 4.06 star energy rating

Options



Remote thermostat



Spacer kit



Canterbury mesh guard kit



Mock fireplace kit



Surround kit (shown on Fitzroy)



Console kit (shown on Fitzroy)



Canterbury Freestanding (CANTFS-SDEEB).

Canterbury Freestanding ★ ★ ★ ★



CANTFS-SDEEB

Elegant, curved appearance that effortlessly suits any home.

The double glazed window allows unobstructed viewing of the flames, creating the perfect feel of a log fire in your home.

An impressive energy rating delivers heat effectively.

Can be safely placed on all floor surfaces making it suitable for the family rooms and large living areas of modern Australian homes.

Standard Features

- + Electronic side controls
- + Electronic ignition
- + 3 heat settings
- + 3 speed fan
- + Realistic eucalypt look logs
- + Standard double glazed glass
- + Enhanced flame effect
- + Metallic black baked enamel finish
- + Flue kit (FLUERO-B) required (purchase separately)
- + Heats 80 m² on average
- + 4.06 star energy rating

Options



Remote thermostat



Canterbury mesh guard kit

Specifications mock fireplace kit

1+2+3+4

Creating the look of a fireplace is simple with Cannon.

If you don't have a fireplace but like the look, our mock fireplace kit is the answer. Using the kit, your inbuilt heater can be easily and safely installed in a plasterboard or timber wall.

Whether flueing up in the wall cavity, through ceiling plaster or through an external wall, simply construct a purpose built timber or plasterboard enclosure to conceal the heater cabinet and / or flue.

Use with inbuilt heater for installation into combustible areas i.e. timber, plasterboard etc. (Kit included with Powerflue model)

Note: The purpose of the diagrams shown here are to briefly illustrate the steps to install a heater in a mock fireplace. For full details refer to the comprehensive instructions included with the heater or visit www.cannonheaters.com.au

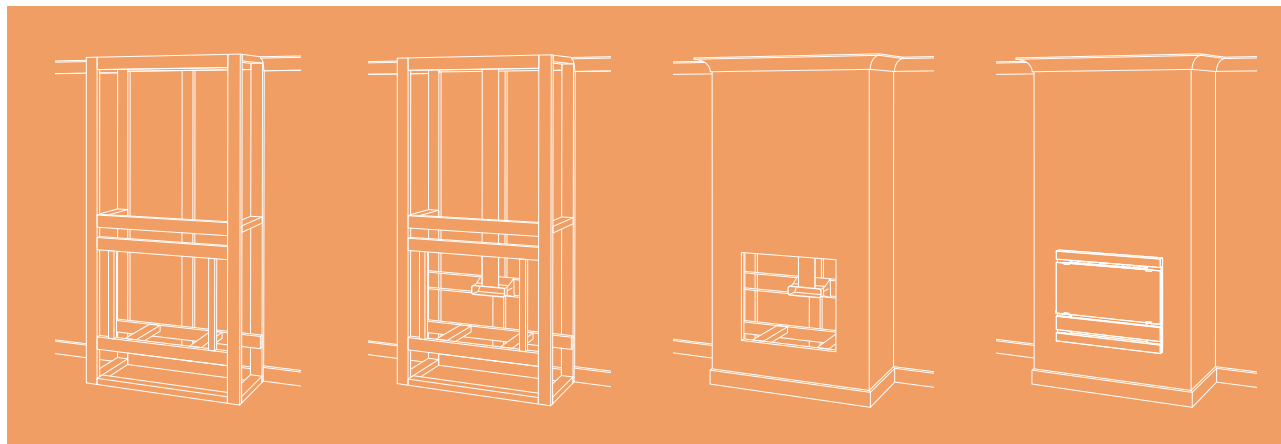

- 1** Choose your location and build a frame to enclose the heater according to your flueing needs. Allow for required clearances between the heater cabinet and combustible surfaces. Refer to mock installation instructions or website for further detailed measurement requirements
- 2** Installation of appropriate self-supported flue which complies with local regulations and manufacturer instructions. Refer to mock installation instructions or website for details on mounting of wall brackets & flue transition (brackets & flue transition are supplied with mock kit only).
- 3** Finish with plasterboard or timber panelling to enclose the frame, maintaining appropriate clearances. Plasterboard opening should be cut back level with timber framework.
- 4** Attach the mock fireplace kit to the heater per the instructions. Position the heater in the frame. Refer to mock installation instructions or website for further details on installing mock kit components on heater.

Mock Fireplace Opening (combustible materials)

	FITZROY INBUILT		FITZROY POWERFLUE		CANTERBURY INBUILT	
	Max	Min	Max	Min	Max	Min
Height	650 mm	630 mm	650 mm	630 mm	645 mm	630 mm
Width	780 mm	745 mm	780 mm	745 mm	780 mm	745 mm
Depth	555 mm*	500 mm*	N/A	See page 27	505 mm*	450 mm*

*Includes 50 mm clearance between flue spigot and rear brickwork.

Specifications Powerflue

Cannon's **Powerflue** has some unique installation and operation advantages.

Unlike standard gas log heaters, the Powerflue can be terminated horizontally from the rear of the unit, eliminating the need for the flue to run up through the wall and protrude above the roofline. This means you can place the heater on any external wall, even in a multi-storey apartment.

The Cannon Fitzroy Powerflue can also be flued up through an internal wall or out under the floor making it truly versatile.

Because the Powerflue model draws air from outside for combustion and then vents outside via a secondary flue, it is safe to install into a bedroom or 5 star energy rated home that is well sealed from draughts.

Standard heater operation.

Flue goes directly through the ceiling and roof.

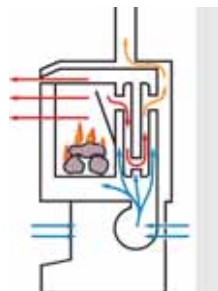

Powerflue operation.

Air is drawn in from outside for combustion and vented outside via the secondary flue.

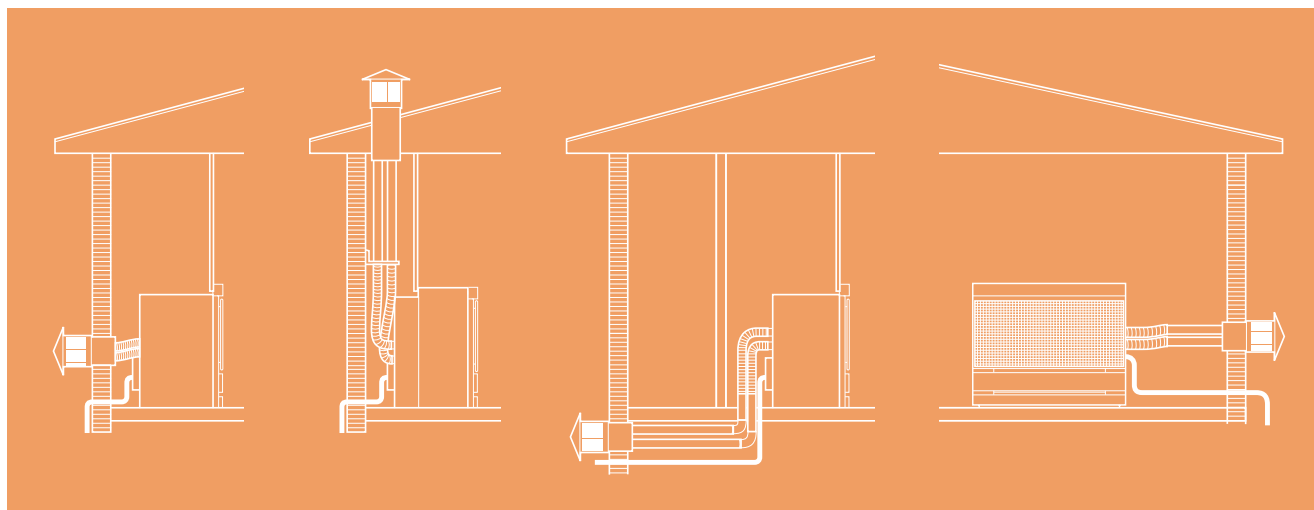
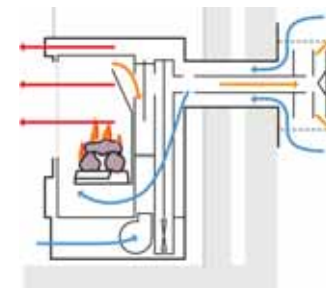

1 Horizontal installation from the back.

2 Vertical installation.

3 Under floor installation.

4 Sideways horizontal installation.

Specifications heaters and features and options guide

	Fitzroy Inbuilt Models				Fitzroy Powerflue Models			
	FITZIB-SMENB-NG	FITZIB-SMENB-LP	FITZIB-SMEXB-NG	FITZIB-SMEXB-LP	FITZIB-SMEXP-NG	FITZIB-SMEXP-LP	FITZIB-PMEXB-NG	FITZIB-PMEXB-LP
Standard Features								
Electronic ignition	•	•	•	•	•	•	•	•
3 heat settings	•	•	•	•	•	•	•	•
3 speed fan	•	•	•	•	•	•	•	•
Realistic eucalypt look logs	•	•	•	•	•	•	•	•
Standard flue	•	•	•	•	•	•		
Power flue							•	•
Mesh guard	•	•	•	•	•	•	•	•
Panoramic view	•	•	•	•	•	•	•	•
Enhanced flame			•	•	•	•	•	•
Black enamel finish	•	•	•	•			•	•
Platinum finish					•	•		
Options								
Remote thermostat	o	o	o	o	o	o	o	o
Glass kit	o	o	o	o	o	o	o	o
Spacer kit	o	o	o	o	o	o	o	o
Surround kit	o	o	o	o	o	o	o	o
Console kit	o	o	o	o	o	o	o	o
Weatherproof box							o	o
Mock fireplace kit	o	o	o	o	o	o	o	o
Freestanding kit	o	o	o	o				

Specifications heaters and features and options guide

Canterbury Inbuilt Models

Canterbury Freestanding Models

	CANTIB-SDEEB-NG	CANTIB-SDEEB-LP	CANTFS-SDEEB-NG	CANTFS-SDEEB-LP
Standard Features				
Electronic ignition	•	•	•	•
3 heat settings	•	•	•	•
3 speed fan	•	•	•	•
Realistic eucalypt look logs	•	•	•	•
Standard flue	•	•	•	•
Enhanced flame	•	•	•	•
Black enamel finish	•	•	•	•
Options				
Remote thermostat	○	○	○	○
Spacer kit	○	○		
Surround kit	○	○		
Console kit	○	○		
Mesh guard kit	○	○	○	○
Mock fireplace kit	○	○		
Flue kit			○	○

When selecting the type of heater, consideration must be given as to the construction of the building with regards to the energy efficiency. This will effect the efficiency of the type of flue selected and how that will operate – e.g. High Energy Efficient rated homes have no allowance for the introduction of fresh air for combustion purposes, therefore issues can arise with reverse flow of air through a standard flue in these homes. Two storey extensions to existing homes can also create reverse air flow through standard flues. Avoid installing standard flue heaters on external perimeter walls of high pitched roof buildings to reduce the possibility of reversed air flow through the standard flue. If in doubt always select the Powerflue as it is not effected by these issues.

Specifications heaters

Fitzroy Inbuilt

Fitzroy Freestanding

FITZIB-SMENB / FITZIB-SMEXB / FITZIB-SMEXP

FITZIB-SMENB or FITZIB-SMEXB to be used with FITZFSKITX-B

Type	Inbuilt	Freestanding / top flue	
Colours	Metallic black baked enamel or platinum finish	Metallic black baked enamel finish	
Thermal input	26 MJ/hr	26 MJ/hr	
Gas type	Natural/LPG	Natural/LPG	
Efficiency rating	4 stars ¹	4 stars ¹	
Heats on average	80 square metres (80 m ²)	80 square metres (80 m ²)	
Fan/heat settings	3 speed / 3 heat	3 speed / 3 heat	
Dimensions	Insert	Fascia	Overall
Height	600 mm	651 mm	863 mm
Width	695 mm	808 mm	808 mm
Depth	348 mm (Depth incl. flue spigot: 355 mm)	50 mm	555 mm Min. distance from centre of flue to wall at rear of heater: 120 mm

Installation

The purpose of these pages is to briefly illustrate the specifications. For full details refer to the comprehensive instructions included with the heater or visit www.cannonheaters.com.au. Whilst every effort is made to provide current information at the time this brochure was produced, continuing product development may mean the enclosed specifications, images and literature may differ.

Gas connection via a ½" copper compression fitting.

A 10 amp socket within 1.5m is needed for the fan. Inbuilt models can be direct wired with accessible isolating switch

¹Tested in 2009 to AS 4553:2008.

Fireplace opening (brick & masonry)

	Max	Min
Height	645 mm	605 mm
Width	780 mm	700 mm
Depth	N/A	405 mm*

* Includes 50 mm clearance between flue spigot and rear brickwork

Suitable for non-combustible or masonry / brick fireplaces or into a mock fireplace using a Mock Kit part No. MOCKKITRO purchased separately.

Kit comprising:

3 x 870 mm lengths of 125 mm dia. painted flue,
1 x 870 mm length of 125 mm dia. plain flue,
1 x ceiling ring,
1 x painted bottom flue spigot,
1 x 125 mm cowl,
1 x 75 mm spigot plain
Fasteners
Free standing casing
1 x flue adaptor

Heater does not require non-combustible base.
Can be installed against a combustible wall with clearances of 40 mm rear, 100 mm side and 900 mm in front of heater. Refer to installation instructions.

Specifications heaters

Fitzroy Powerflue

Canterbury Inbuilt

Canterbury Freestanding

FITZIB-PMEXB

CANTIB-SDEEB

CANTFS-SDEEB

Inbuilt Powerflue with variable flue options

Inbuilt

Freestanding / top flue

Metallic black baked enamel finish

Metallic black baked enamel finish

Metallic black baked enamel finish

26 MJ/hr

26 MJ/hr

26 MJ/hr

Natural Gas / LPG

Natural/LPG

Natural/LPG

5.0 star for units with flue 400mm long
5.5 star for units with flue 6.0m long

4 stars¹

4 stars¹

80 square metres (80 m²)

80 square metres (80 m²)

80 square metres (80 m²)

3 speed / 3 heat

3 speed / 3 heat

3 speed / 3 heat

Insert

Fascia

Insert

Fascia

Overall

600 mm

650 mm

600 mm

650 mm

723 mm

695 mm

808 mm

695 mm

850 mm

650 mm

436 mm
including flue spigot

50 mm

300 mm
(Depth incl. flue spigot:
335 mm)

125 mm

425 mm
Min. distance from flue centre to wall
at rear of heater: Round - 115 mm.

Fireplace opening (brick & masonry)

	Max	Min
Height	645 mm	605 mm
Width	780 mm	700 mm
Depth		see page 27

Dimensions of flue

Flue and air inlet through 50 mm diameter aluminium & PVC pipes
2 x 400 mm lengths of 50 mm flexible aluminium hose
Inner flue: 50 mm diameter
Outer flue: 160 mm diameter

Dimensions of flue terminal

Max. length of flue: 6.0 m
Min. length of flue: 130 mm
Flue terminal: 160 mm outer diameter.
150 mm deep (horizontal)
220 mm high (vertical)

See installation instructions for further details.
Mock Kit Part No. MOCKKITRO included.

Fireplace opening (brick & masonry)

	Max	Min
Height	645 mm	605 mm
Width	780 mm	700 mm
Depth		385 mm*

* Includes 50 mm clearance between flue spigot and rear brickwork.

Suitable for non-combustible fireplaces ie. masonry, brick or into a mock fireplace using a Mock kit part No. MOCKKITRO purchased separately.

Flue kit comprising:

3 x 870 mm lengths of 125 mm dia. painted flue,
1 x 870 mm length of 125 mm dia. plain flue,
1 x ceiling ring,
1 x 125 mm cowl,
1 x painted bottom flue spigot.

Heater does not require non-combustible base. Can be installed against a combustible wall with clearances of 40 mm rear, 100 mm side and 900 mm in front of heater. This model to be installed with a Round Flue Kit part No. FLUERO-B purchased separately.

Specifications heaters – continued

Fitzroy Inbuilt

FITZIB-SMENB / FITZIB-SMEXB / FITZIB-SMEXP

With the Cannon range, extensive remodelling to accommodate your new heater is not required. Whether you choose freestanding or inbuilt, Cannon Gas Log Heaters blend so seamlessly into your house, townhouse or flat, you'll forget they're an addition. Attractive surrounds accommodate any size discrepancies with style and grace. And the Powerflue offers unsurpassed installation choices with horizontal and vertical flueing options to any external wall. This range truly demonstrates a mastery of flexibility and versatility.

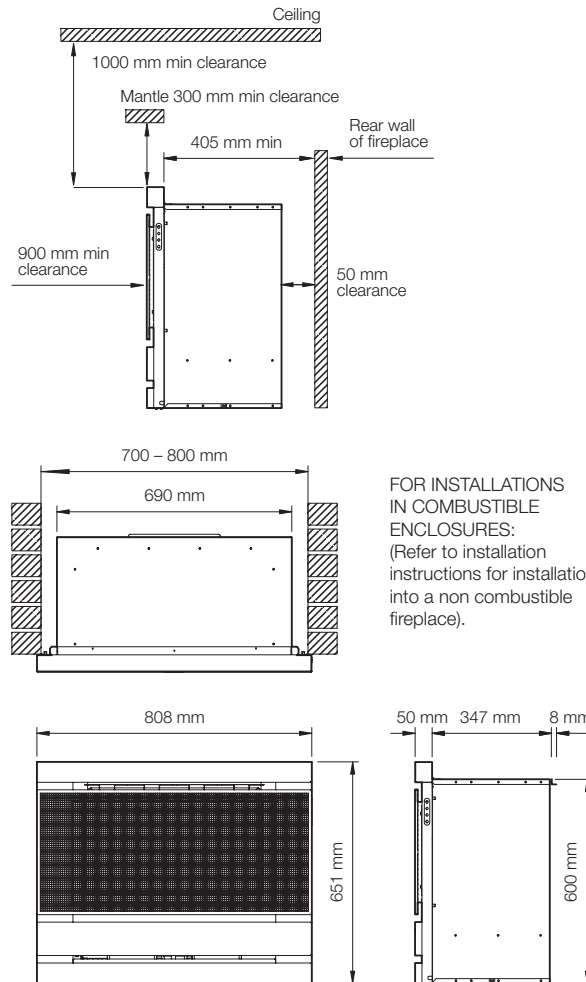

Fitzroy Freestanding

FITZIB-SMENB or FITZIB-SMEXB to be used with FITZFSKITX-B

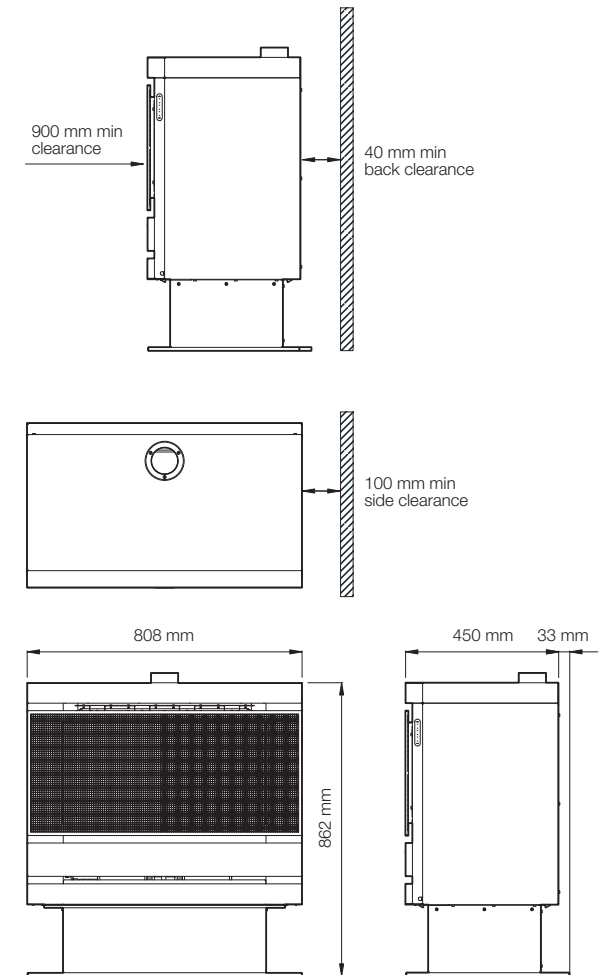

Specifications heaters – continued

Fitzroy Powerflue

FITZIB-PMEXB

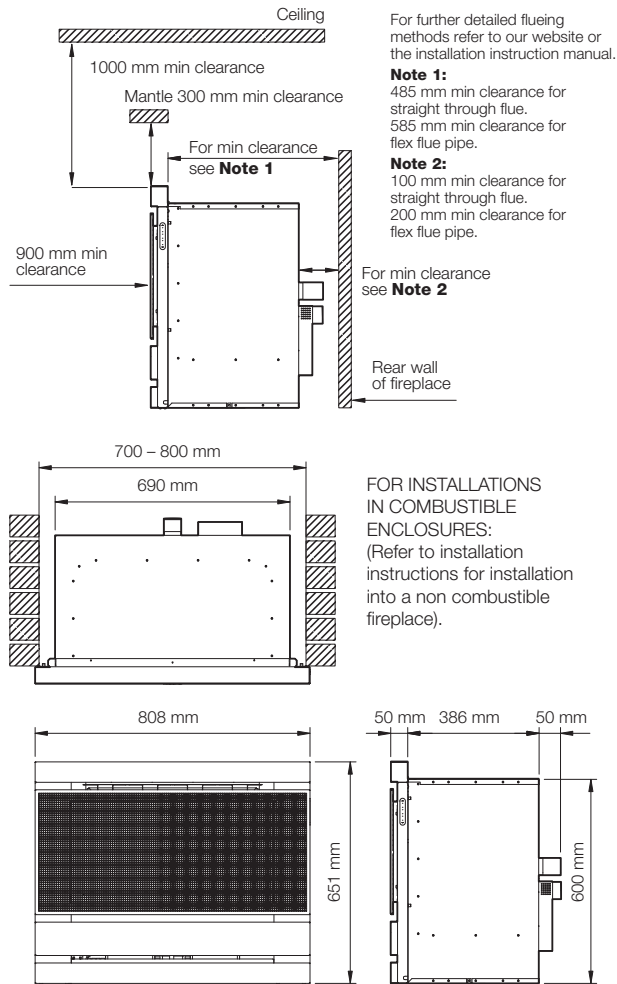

Canterbury Inbuilt

CANTIB-SDEEB

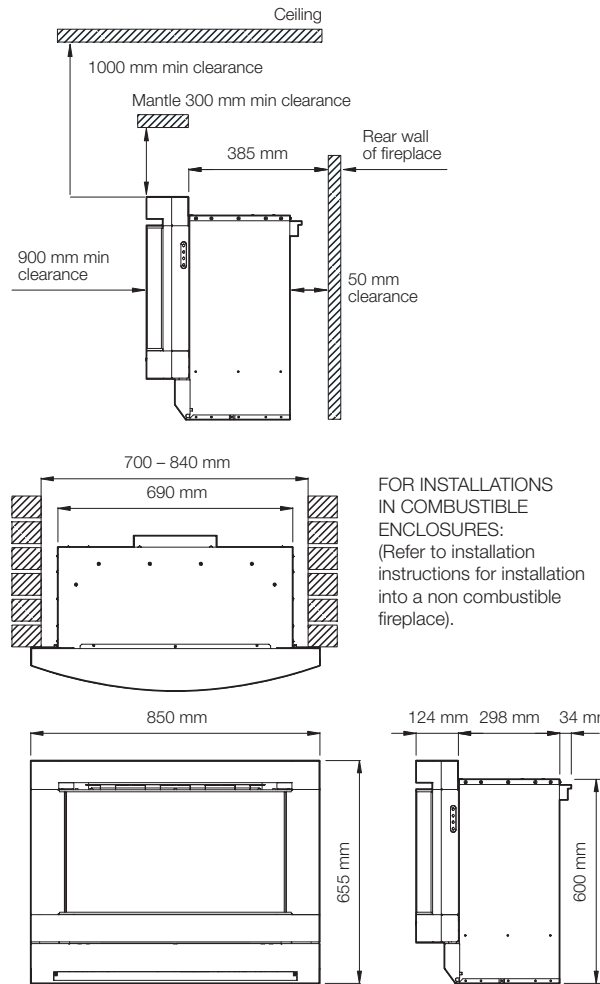

Canterbury Freestanding

CANTFS-SDEEB

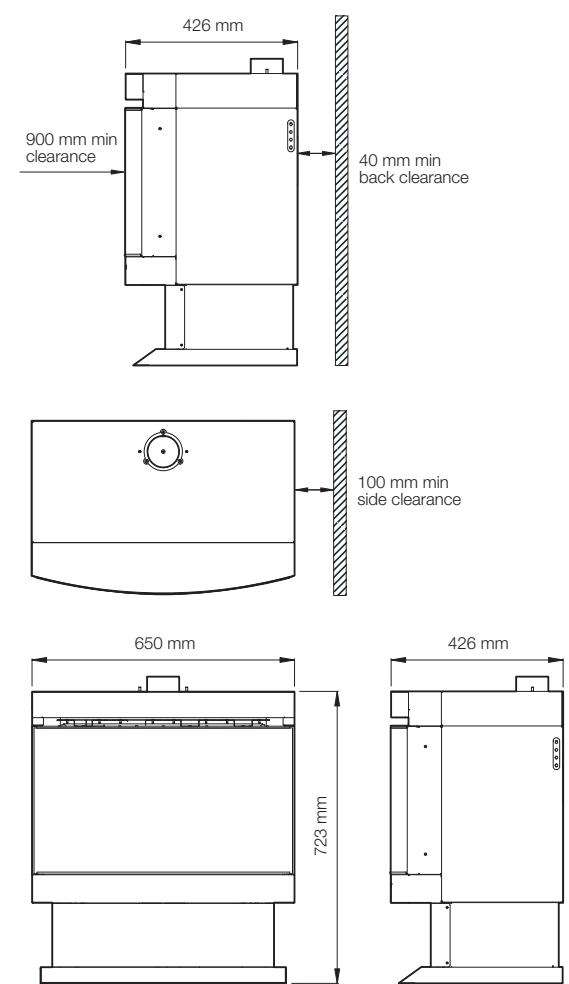

Cannon[®]
Gas Log Heaters

430 Johnston Street,
Abbotsford, Victoria,
Australia, 3066



wignells
of melbourne

THE HOME OF CHEMINÉES PHILIPPE AUSTRALIA

Sampford IXL

*Proudly manufactured and
distributed by Sampford IXL*

Sampford IXL Pty Ltd
(Head Office)
421 Smith Street, Fitzroy,
Victoria 3065
Telephone: 1300 727 421
Fax: 1300 727 425
www.cannonheaters.com.au

To locate your nearest retailer,
view product on display or for
all national enquiries contact
1300 727 421 or visit
www.cannonheaters.com.au